

315 mm BENDS

Pipe diameter (mm)	RAD	W	X	Y	Z	Straight length (mm)
11 ¼ °	1200	670	380	450	300	
22 ½ °	1200	880	490	550	300	
45 °	1200	1200	500	450	300	
90 °	1400	2500	500	600	300	

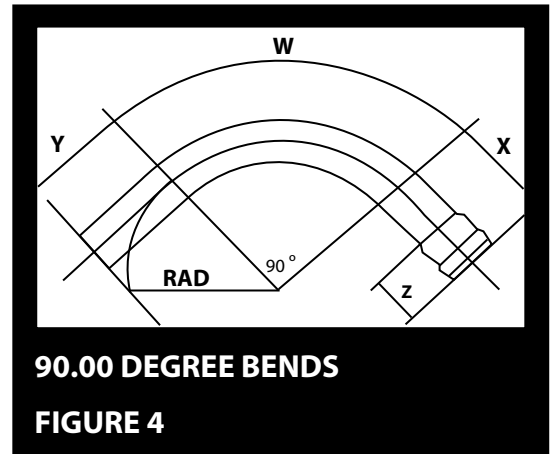

ZLOK BENDS

11.25 mm BENDS

Pipe diameter (mm)	RAD	W	X	Y	Z	Straight length (mm)
50	135	60	120	100	100	280
63	190	90	145	110	125	350
75	190	130	170	130	140	430
90	210	130	175	175	140	480
110	280	160	190	160	150	520
125	320	160	195	200	150	570
140	350	160	235	240	165	650
160	400	225	255	245	195	700
200	520	210	350	250	260	800
250	750	230	380	280	260	1000

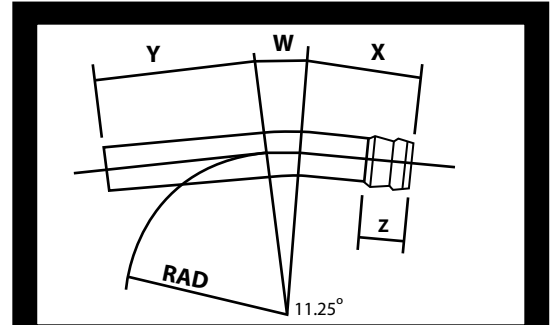

11.25 DEGREE BENDS

FIGURE 1

22.50 DEGREE BENDS

Pipe diameter (mm)	RAD	W	X	Y	Z	Straight length (mm)
50	130	95	115	100	100	300
63	190	140	150	110	125	400
75	190	180	170	130	140	480
90	210	160	195	175	140	530
110	280	220	180	140	150	550
125	320	250	190	200	150	600
140	350	280	215	200	165	700
160	400	330	210	210	195	750
200	520	310	380	320	260	1000
250	790	380	310	410	260	1100

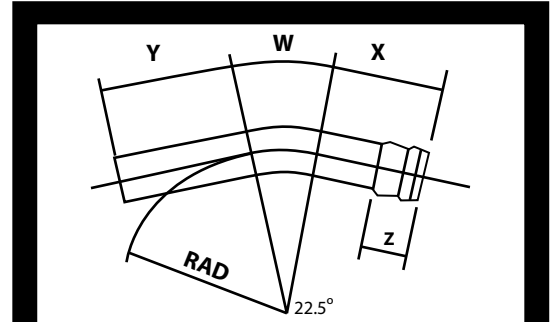

22.50 DEGREE BENDS

FIGURE 2

45 DEGREE BENDS

Pipe diameter (mm)	RAD	W	X	Y	Z	Straight length (mm)
50	130	130	120	110	100	350
63	190	185	130	125	125	460
75	190	235	165	145	140	530
90	210	235	180	165	140	580
110	280	290	180	180	150	650
125	320	300	175	210	150	650
140	350	380	215	205	165	800
160	400	390	195	300	195	850
200	520	590	340	300	260	1200
250	850	480	370	450	270	1300

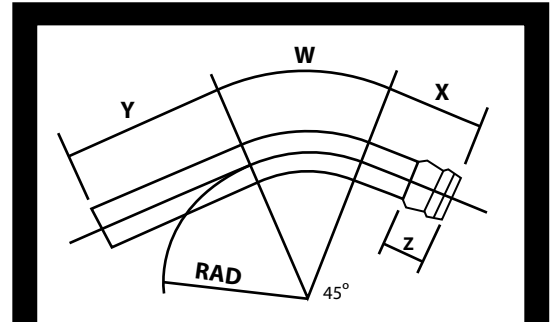

45 DEGREE BENDS

FIGURE 3

90 DEGREE BENDS

Pipe diameter (mm)	RAD	W	X	Y	Z	Straight length (mm)
50	130	210	120	130	100	450
63	190	300	145	110	125	550
75	190	310	170	130	140	600
90	210	325	175	160	140	650
110	280	490	190	190	150	850
125	320	540	210	220	150	950
140	350	570	210	220	165	1000
160	400	560	240	220	195	1050
200	520	800	350	300	260	1400
250	1100	870	310	420	260	1600

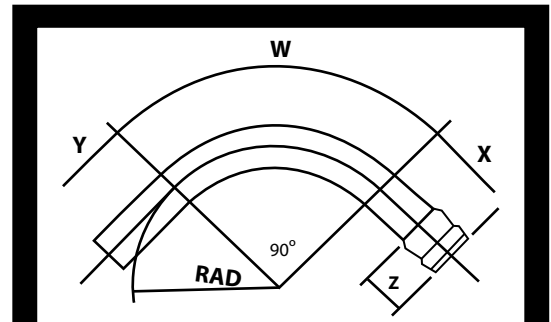

90 DEGREE BENDS

FIGURE 4

355 X 90° Zoe Bend

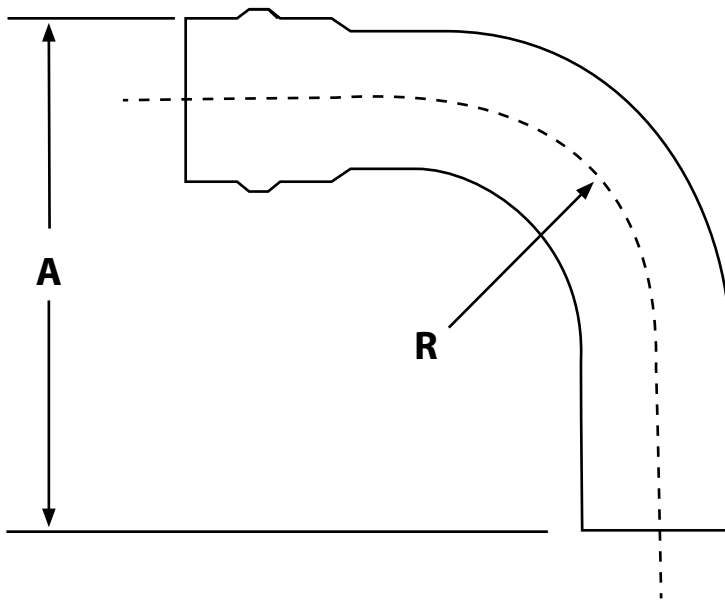

A = 2500mm

R = 1800mm

400 X 90° Zoe Elbow

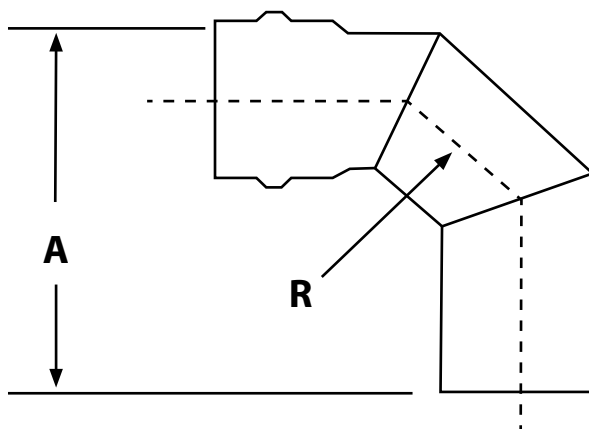

A = 1200 mm

R = 650 mm

LOBSTER BEND

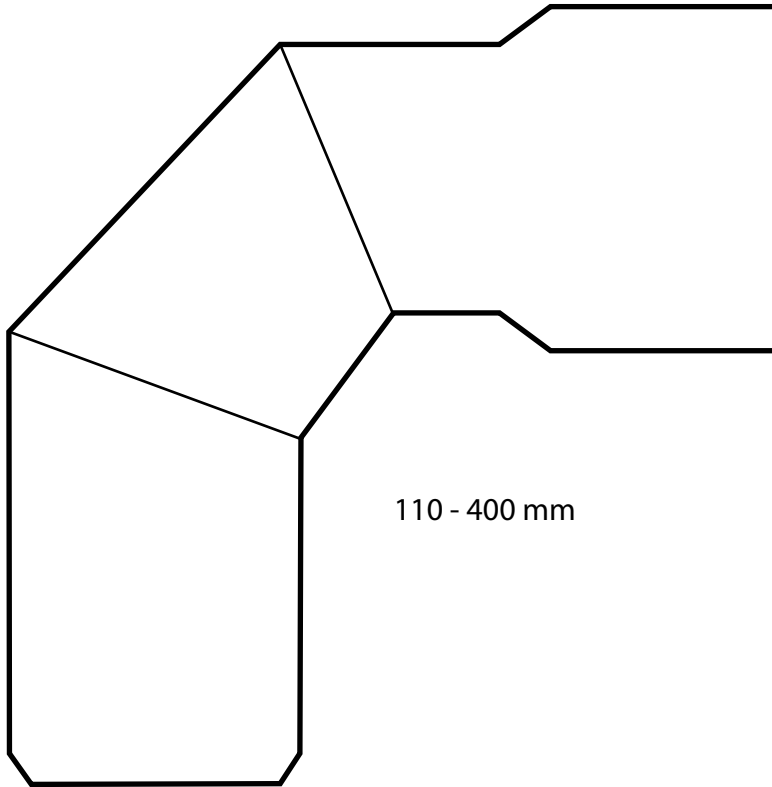

110 - 400 mm

REDUCER

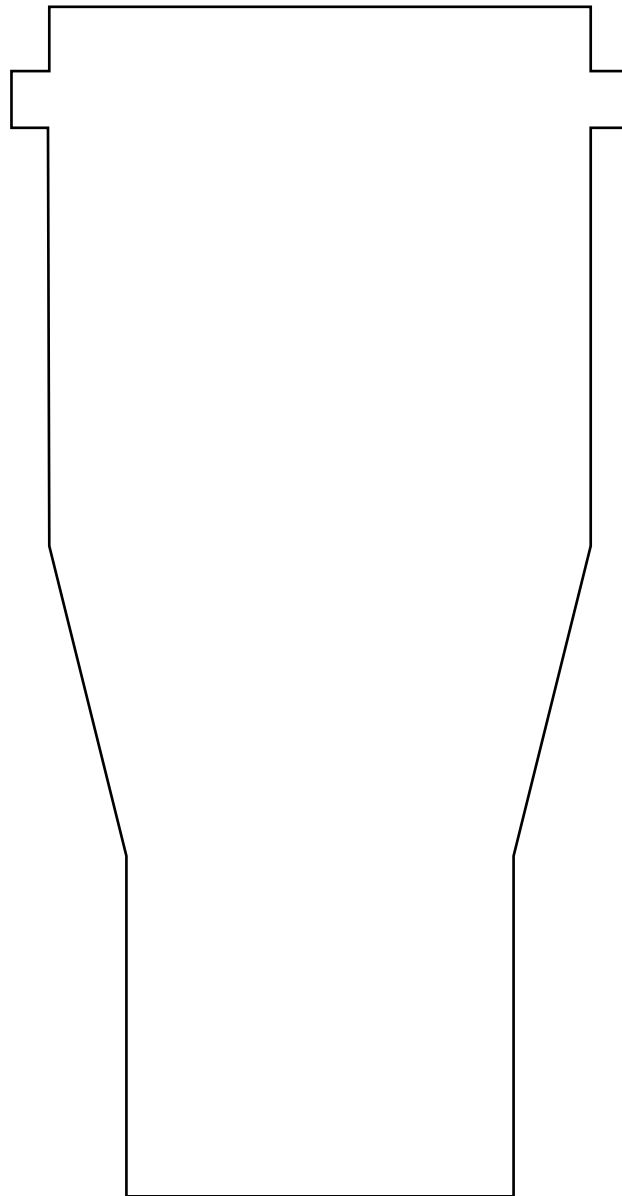

63 - 50 mm
to
315 - 250 mm

LOBSTER BEND

From 110 - 400 mm

From 250 - 400 mm

1 Sgment

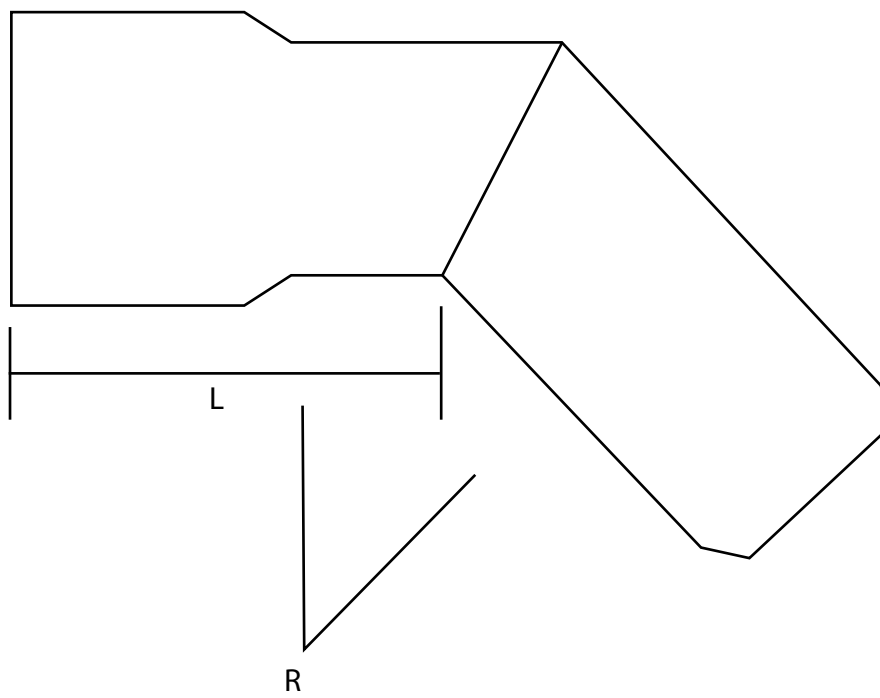

REDUCING JUNCTION

- 160 - 110
- 200 - 110
- 250 - 110
- 315 - 100
- 400 - 110

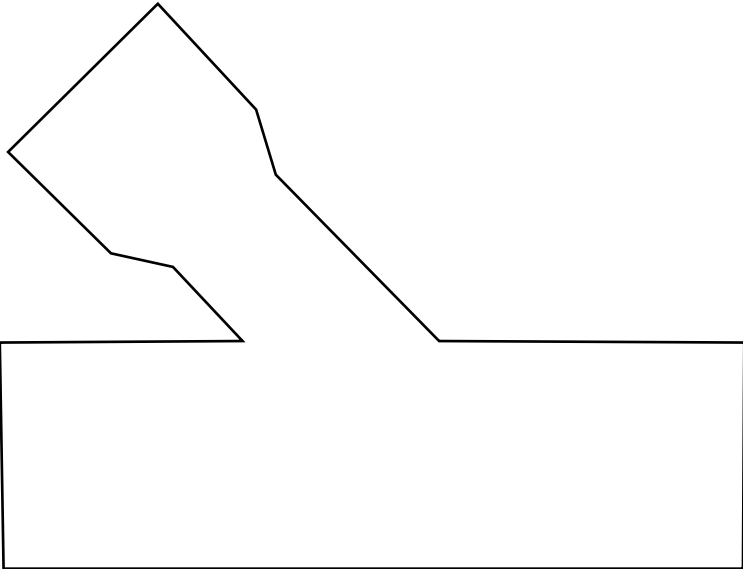

EQUAL TEES

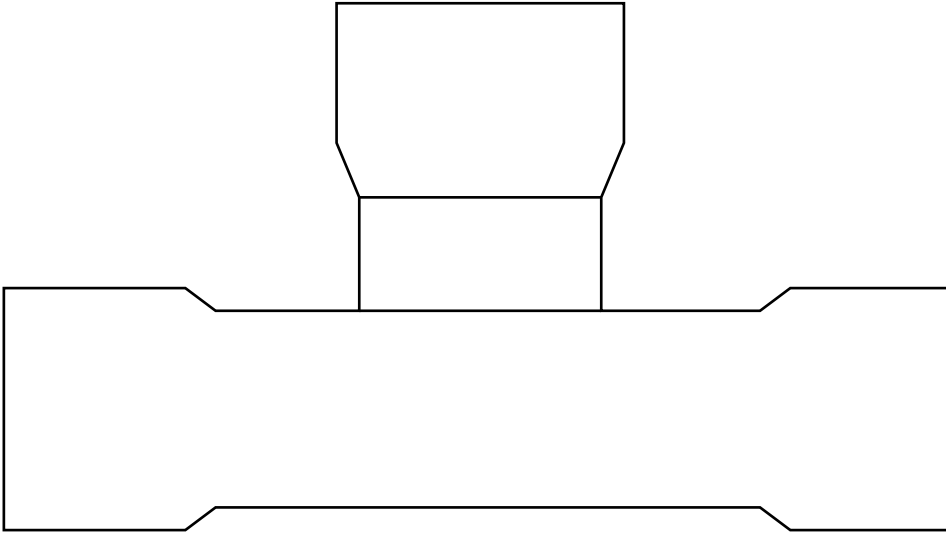

ELBOW

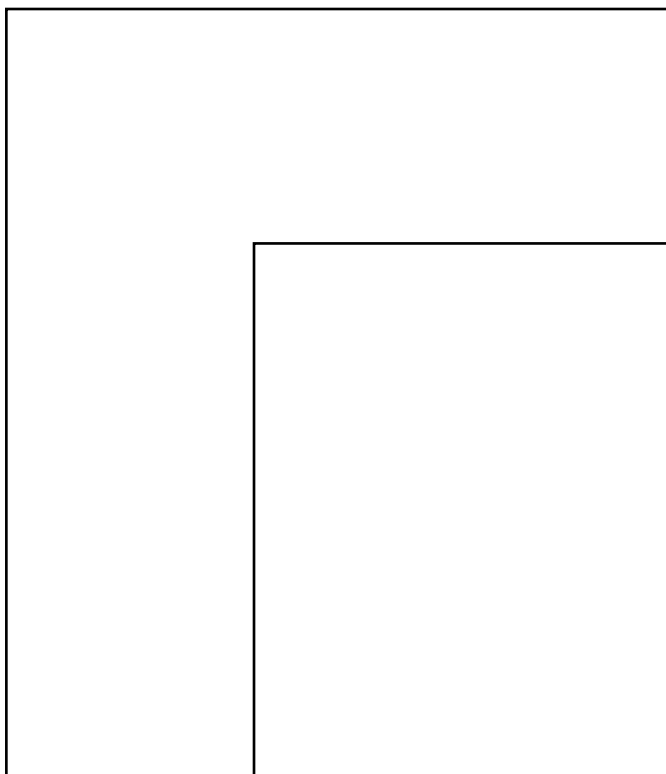

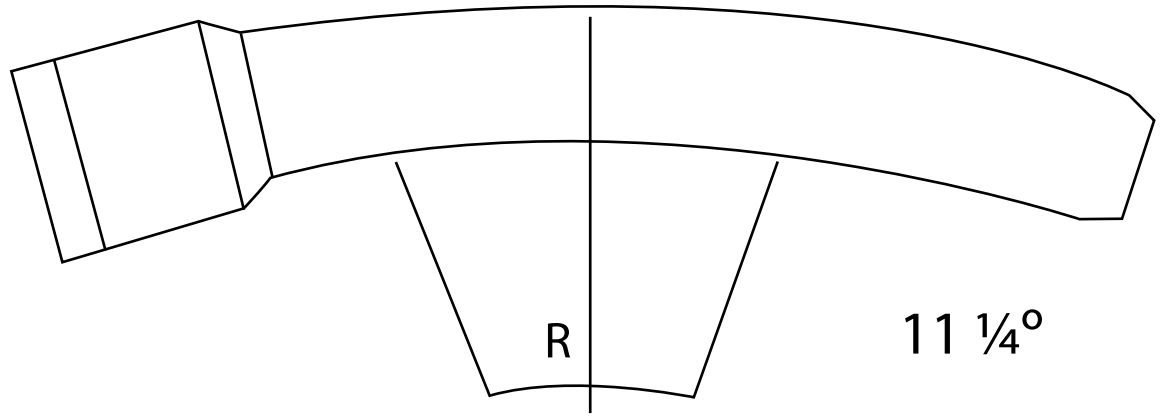
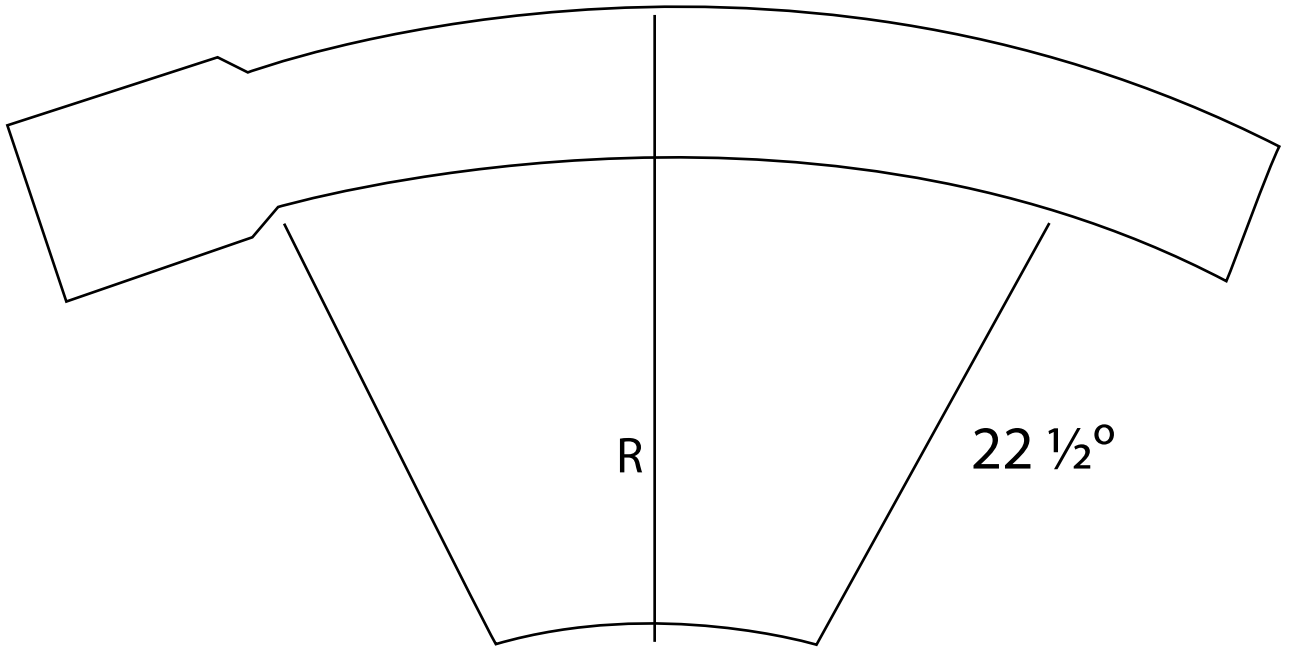

Bend from
50mm

From 250mm
90°

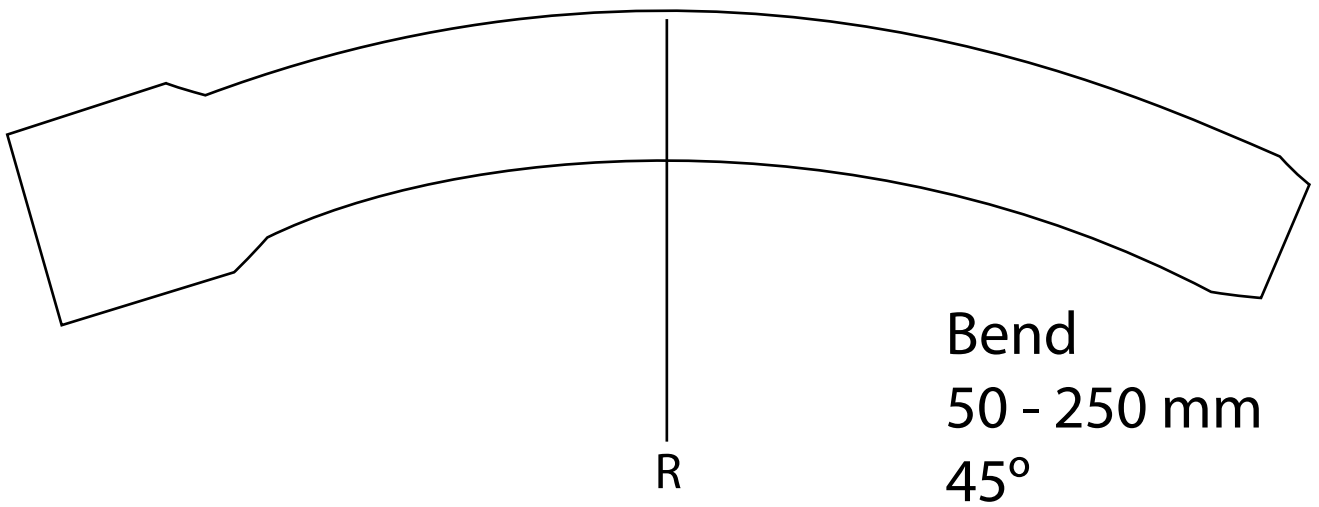
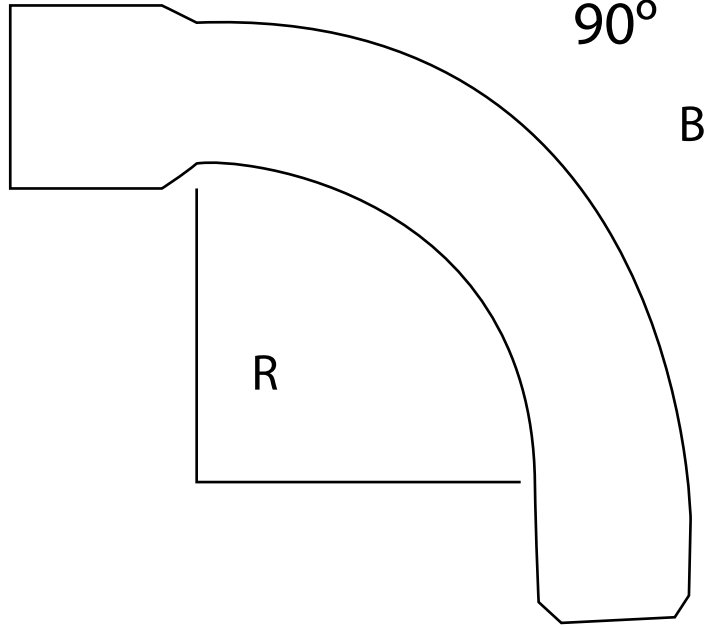

Bend
50 - 250 mm
45°